**remove
odstranit**

4x

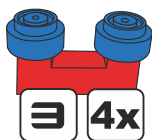

1

17

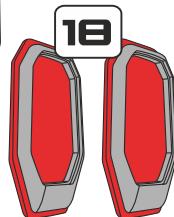
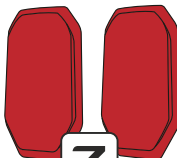
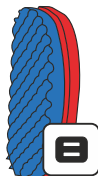
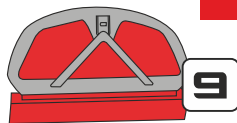
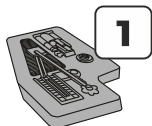
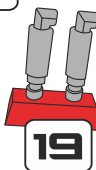
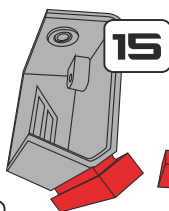
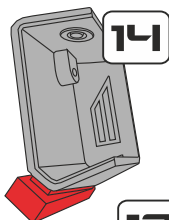
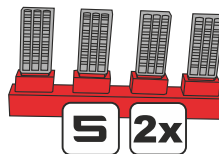
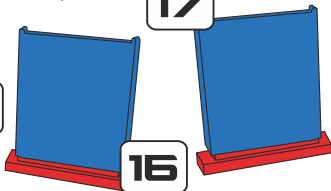

2x



2

16

10

11

5



12

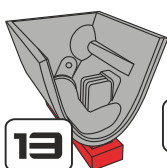

13



6

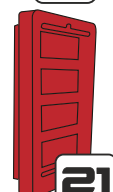

21

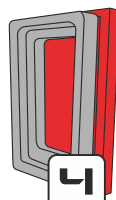

4

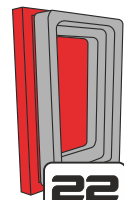

22



This set contain metal detail parts for upgrading scale plastic models.

When upgrading the model some cutting or corrections may be necessary for parts to fit accurately.

WARNING!

This set may contain small and sharp parts. Work carefully in a ventilated and well-lit room. Safety glasses are recommended. This product is not suitable for children less than 14 years old.

Tento set obsahuje kovové díly pro úpravu a vylepšení

plastického modelu. Pro přesnou aplikaci dílů může být zapotřebí přípravy dílů upravovaného modelu.

VAROVÁNÍ!

Tento set může obsahovat malé a ostré díly. Pracujte ve větrané a dobře osvětlené místnosti. Doporučujeme použít ochranné brýle. Tento výrobek není vhodný pro děti mladší 14let.

**remove
odstranit****option
volba****opposite side
protější strana****bend
ohnout****drill
vrtat****grind
brousit****fill
vytmelit****PE part
kovový díl****resin part
resinový díl****decals part
obtiskový díl****mask part
maska díl**

01.

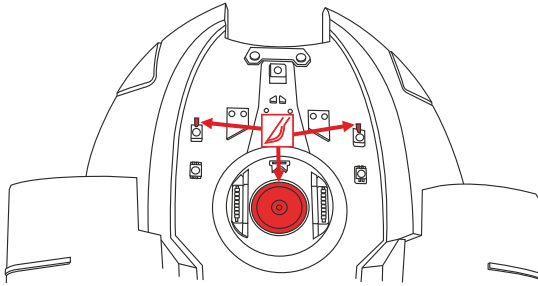

02.

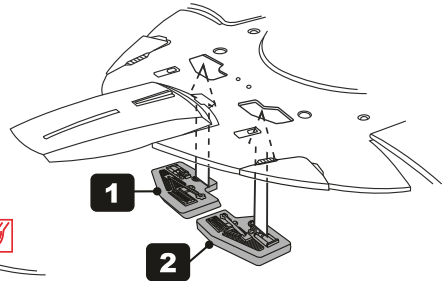
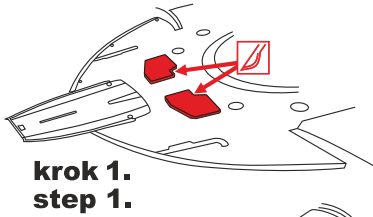

03.

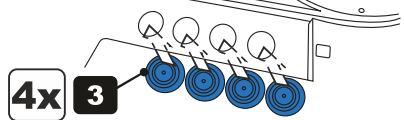
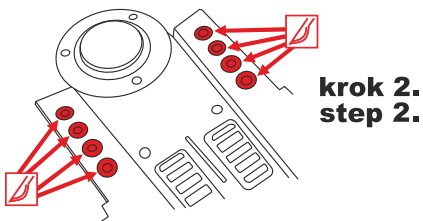
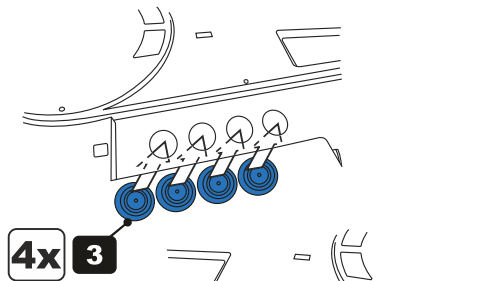
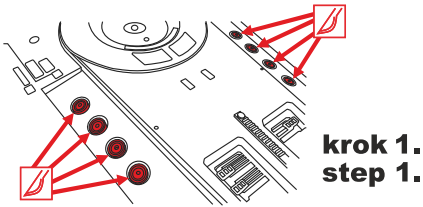

04.

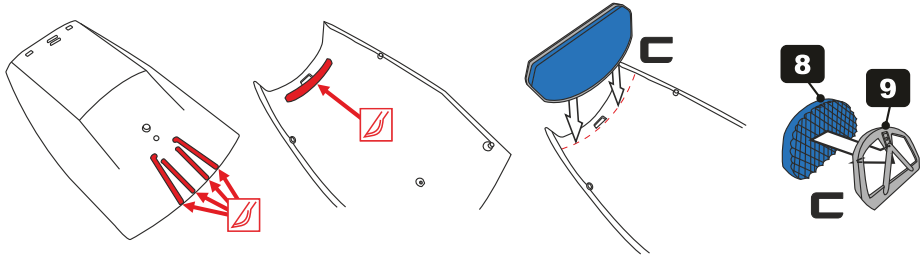

05.

krok 1
step 1

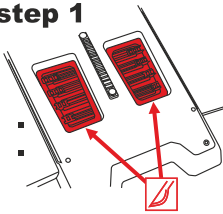

krok 2.
step 2.

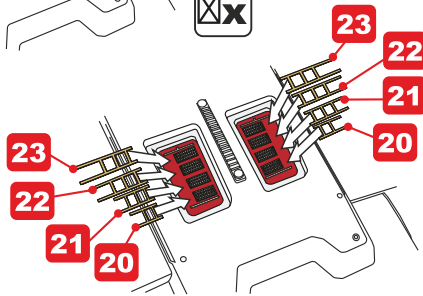
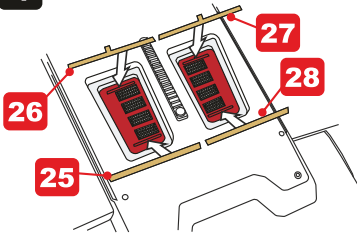
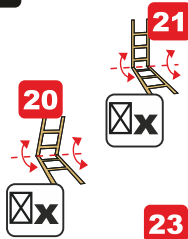
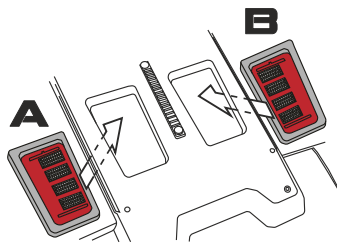
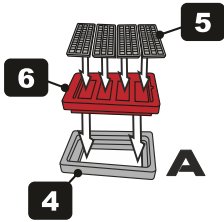
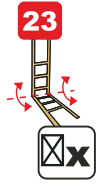
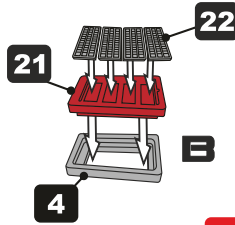
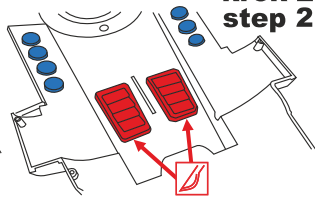

06.

krok 1.
step 1.

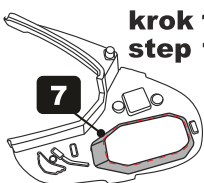

krok 2.
step 2.

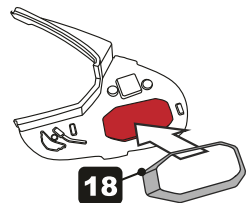
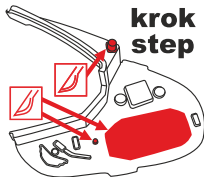

07.

2x

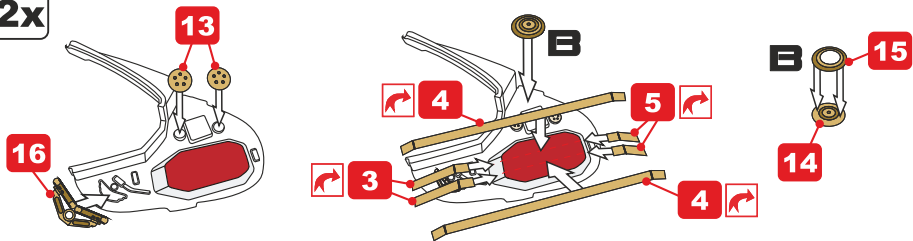

08.

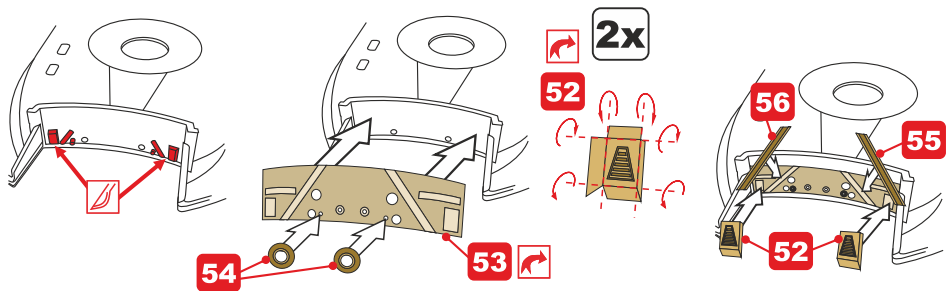

09.

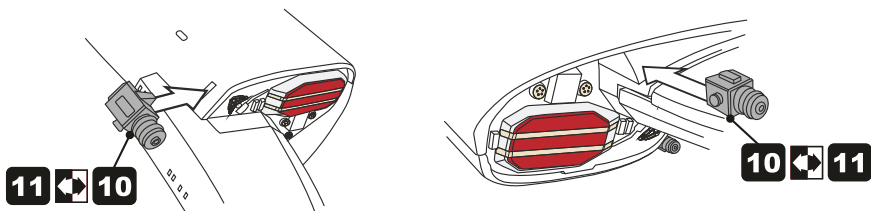

10.

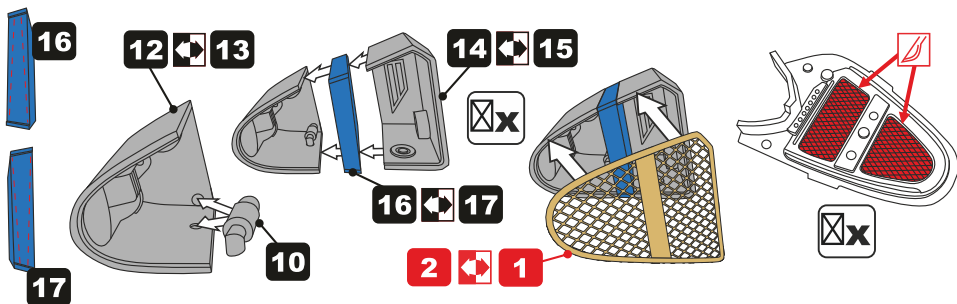

11.

2x

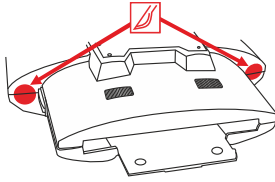
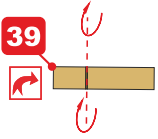

2x

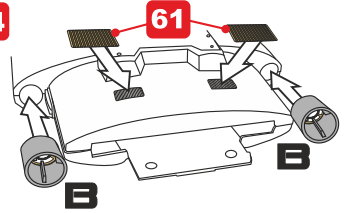

2x

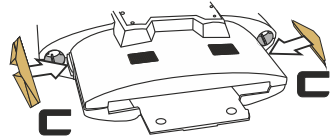
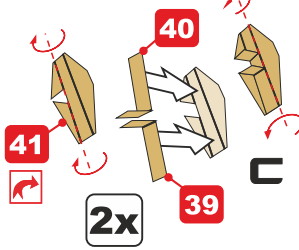
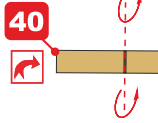

12.

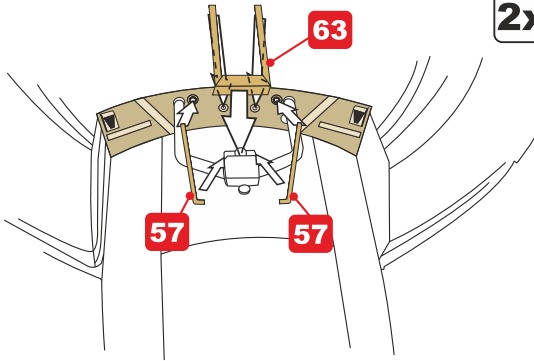

2x

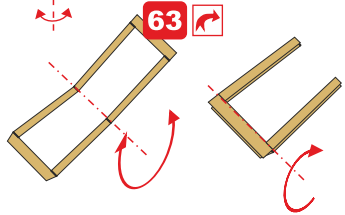

13.

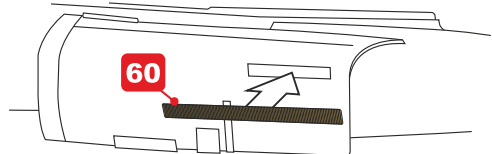
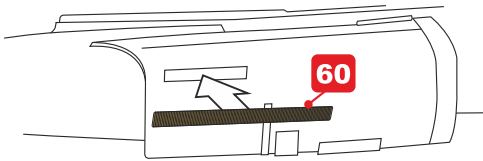

14.

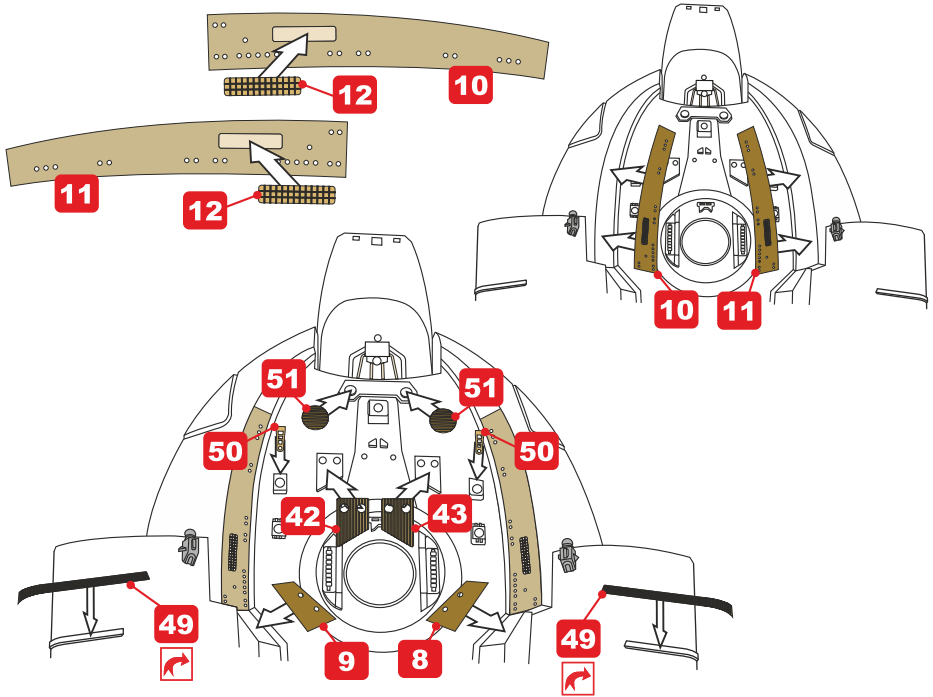

15.

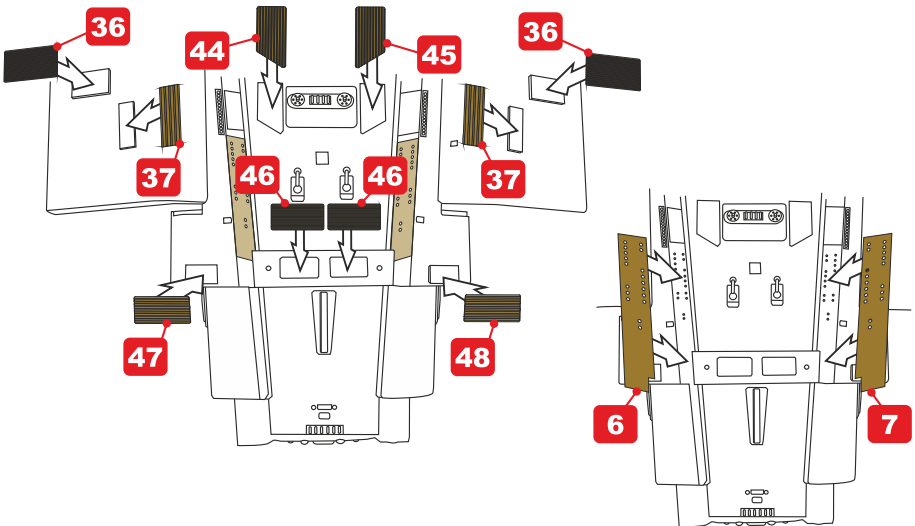

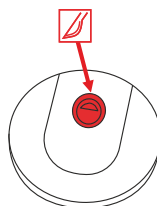
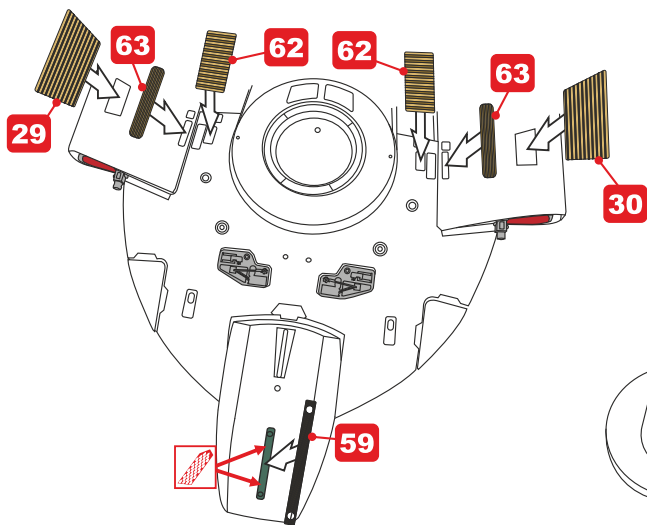

**krok 1.
step 1.**

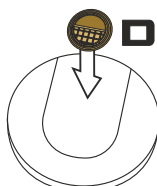

**krok 2.
step 2.**

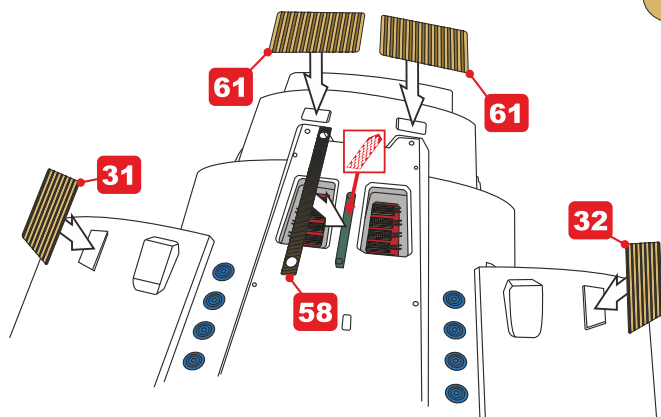
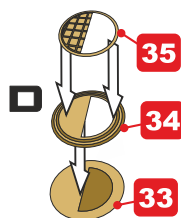

17.

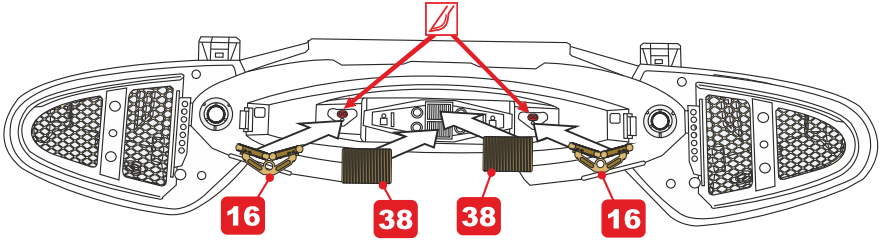

18.

